

MEDICATION GUIDE

FYCOMPA® (fi-COM-puh)
(perampanel)
tablets, for oral use, CIII

FYCOMPA® (fi-COM-puh)
(perampanel)
oral suspension, CIII

What is the most important information I should know about FYCOMPA?

1. FYCOMPA may cause mental (psychiatric) problems, including:

- new or worse aggressive behavior (including homicidal behavior), hostility, anger, anxiety, or irritability
- being suspicious or distrustful (believing things that are not true)
- seeing objects or hearing things that are not there
- confusion
- difficulty with memory
- other unusual or extreme changes in behavior or mood

Tell your healthcare provider right away if you have any new or worsening mental problems while taking FYCOMPA.

2. Like other antiepileptic drugs, FYCOMPA may cause suicidal thoughts or actions in a very small number of people, about 1 in 500.

Call a healthcare provider right away if you have any of these symptoms, especially if they are new, worse, or worry you:

- thoughts about suicide or dying
- new or worse depression
- feeling agitated or restless
- trouble sleeping (insomnia)
- acting aggressive, being angry, or violent
- an extreme increase in activity and talking (mania)
- attempt to commit suicide
- new or worse anxiety
- panic attacks
- new or worse irritability
- acting on dangerous impulses
- other unusual changes in behavior or mood

Suicidal thoughts or actions can be caused by things other than medicines. If you have suicidal thoughts or actions, your healthcare provider may check for other causes.

How can I watch for early symptoms of suicidal thoughts and actions?

- Pay attention to any changes, especially sudden changes, in mood, behaviors, thoughts, or feelings.
- Keep all follow-up visits with your healthcare provider as scheduled.

Call your healthcare provider between visits as needed, especially if you are worried about symptoms.

Do not stop FYCOMPA without first talking with a healthcare provider. Stopping FYCOMPA suddenly can cause serious problems. Stopping FYCOMPA suddenly can cause you to have seizures more often.

What is FYCOMPA?

FYCOMPA is a prescription medicine used:

- to treat partial-onset seizures with or without secondarily generalized seizures in people with epilepsy who are 4 years of age and older
- with other medicines to treat primary generalized tonic-clonic seizures in people with epilepsy who are 12 years of age and older

FYCOMPA is a controlled substance (CIII) because it can be abused or lead to drug dependence. Keep your FYCOMPA in a safe place to protect it from theft. Never give your FYCOMPA to anyone else because it may harm them. Selling or giving away this medicine is against the law.

It is not known if FYCOMPA is safe and effective for partial onset seizures in children under 4 years of age or for primary generalized tonic clonic seizures in patients under 12 years of age.

Before taking FYCOMPA, tell your healthcare provider about all of your medical conditions, including if you:

- have or have had depression, mood problems, aggressive or hostile behavior (for example, homicidal behavior), suicidal thoughts or behavior, or other psychiatric problems.
- have liver or kidney problems
- drink alcohol
- have abused prescription medicines, street drugs, or alcohol in the past
- are pregnant or plan to become pregnant. It is not known if FYCOMPA will harm your unborn baby.
 - If you become pregnant while taking FYCOMPA, talk to your healthcare provider about registering with the North American Antiepileptic Drug Pregnancy Registry. You can enroll in this registry by calling 1-888-233-2334 or go to <http://www.aedpregnancyregistry.org>. The purpose of this registry is to collect information about the safety of FYCOMPA and other antiepileptic medicine during pregnancy.
- are breastfeeding or plan to breastfeed. It is not known if FYCOMPA passes into your breast milk. Talk to your healthcare provider about the best way to feed your baby if you take FYCOMPA. You and your healthcare provider should decide if you will take FYCOMPA or breastfeed. You should not do both.

Tell your healthcare provider about all the medicines you take, including prescription and over-the-counter medicines, vitamins, and herbal supplements.

Taking FYCOMPA with certain other medicines can cause side effects or reduce the benefit of either drug. **Especially tell your healthcare provider if you take:**

- contraceptives (birth control). FYCOMPA may lower your contraceptive's ability to prevent pregnancy if your contraceptive contains levonorgestrel. Use an additional non-hormonal form of contraception (like condoms or a diaphragm and spermicide) while using FYCOMPA and for 1 month after you have stopped taking FYCOMPA.
- carbamazepine (CARBATROL, TEGRETOL, TEGRETOL-XR, EQUETRO, EPITOL)
- phenytoin (DILANTIN, PHENYTEK)
- oxcarbazepine (TRILEPTAL)
- rifampin (RIFADIN, RIMACTANE)
- St. John's Wort

How should I take FYCOMPA?

- See the Instructions for Use below for complete information on how to use the dosing syringes and how to measure the dose of FYCOMPA Oral Suspension.
- Take FYCOMPA exactly as your healthcare provider tells you. Your healthcare provider will tell you how much FYCOMPA to take and when to take it. FYCOMPA is usually taken 1 time a day at bedtime.
- Your healthcare provider may change the dose. Do not change the dose without talking to your healthcare provider.
- If you take FYCOMPA Oral Suspension, shake the bottle well before you take each dose.
- Measure the dose of FYCOMPA Oral Suspension using the bottle adapter and dosing syringes provided. **Do not** use a household teaspoon.
- Talk to your healthcare provider about what to do if you miss more than 1 dose of FYCOMPA.
- If you take too much FYCOMPA, call your local Poison Control Center or go to the nearest hospital emergency room right away.

What should I avoid while taking FYCOMPA?

- Do not drive, operate heavy machinery, or do other dangerous activities until you know how FYCOMPA affects you. FYCOMPA may make you dizzy, sleepy, or tired.
- Do not drink alcohol or take other medicines that make you sleepy or dizzy while taking FYCOMPA until you talk to your healthcare provider. FYCOMPA taken with alcohol or medicines that cause sleepiness or dizziness may make your sleepiness or dizziness worse. FYCOMPA when taken with alcohol may also make your mood worse, increase anger, confusion, and depression.

What are the possible side effects of FYCOMPA?

See **"What is the most important information I should know about FYCOMPA?"**

FYCOMPA may cause other serious side effects, including:

- **Dizziness, vertigo (sense of spinning), and problems walking normally.** You may have problems walking normally if you are unsteady because you feel dizzy. These symptoms can increase when the dose of FYCOMPA is increased. Your risk of feeling dizzy and having problems walking normally may be higher if you are elderly.
- **Sleepiness and tiredness.** See **"What should I avoid while taking FYCOMPA?"**
- **Increased risk of falls.** Taking FYCOMPA can increase your chance of falling. These falls can cause serious injuries. Your risk of falling may be higher if you are elderly.
- **A serious allergic reaction that may affect your skin or other parts of your body such as your liver, kidneys, heart, or blood cells.** This allergic reaction can be life-threatening and can cause death. Call your healthcare provider right away if you have:
 - a skin rash, hives
 - fever or swollen glands that do not go away
 - swelling of your face
 - shortness of breath, swelling of the legs, yellowing of the skin or whites of the eyes, or dark urine.

The most common side effects of FYCOMPA include:

- | | | |
|----------------|-------------------------------------|------------------|
| • dizziness | • nausea and vomiting | • headache |
| • sleepiness | • weight gain | • bruising |
| • tiredness | • vertigo (sense of spinning) | • abdominal pain |
| • irritability | • problems walking normally | • anxiety |
| • falls | • problems with muscle coordination | |

These are not all of the possible side effects of FYCOMPA. For more information ask your healthcare provider or pharmacist.

Call your doctor for medical advice about side effects. You may report side effects to FDA at 1-800-FDA-1088.

How should I store FYCOMPA?

- Store FYCOMPA tablets at room temperature between 68°F to 77°F (20°C to 25°C).
- Store FYCOMPA oral suspension below 86°F (30°C). **Do not** freeze.
- Replace the cap tightly after opening.
- Use FYCOMPA oral suspension within 90 days after the bottle is first opened.

Keep FYCOMPA and all medicines out of the reach of children.

General information about the safe and effective use of FYCOMPA.

Medicines are sometimes prescribed for purposes other than those listed in a Medication Guide. Do not use FYCOMPA for a condition for which it was not prescribed. Do not give FYCOMPA to other people, even if they have the same symptoms you have. It may harm them. You can ask your pharmacist or healthcare provider for information about FYCOMPA that is written for health professionals.

What are the ingredients in FYCOMPA?

Active ingredient: perampanel

Inactive ingredients (tablets): lactose monohydrate, low substituted hydroxypropyl cellulose, povidone, microcrystalline cellulose, magnesium stearate, hypromellose, polyethylene glycol, talc, and titanium dioxide. Tablets of different strengths also may contain yellow ferric oxide (10 mg and 2 mg), red ferric oxide (2 mg, 4 mg, 6 mg, 8 mg), black ferric oxide (8 mg), and FD&C blue # 2 (indigo carmine) aluminum lake (10 mg and 12 mg).

Inactive ingredients (oral suspension): sorbitol, microcrystalline cellulose, carboxymethylcellulose sodium, poloxamer, simethicone, citric acid, sodium benzoate, and purified water.

Marketed by Catalyst Pharmaceuticals, Inc., Coral Gables, FL 33134

Manufactured by Eisai Inc. for Catalyst Pharmaceuticals, Inc.

FYCOMPA® is a trademark owned by Catalyst Pharmaceuticals, Inc. For more information, go to www.FYCOMPA.com or 1-844-347-3277.

©2023 Catalyst Pharmaceuticals, Inc.

This Medication Guide has been approved by the U.S. Food and Drug Administration

Revised: 06/2023

Instructions for Use
FYCOMPA® (fi-COM-puh)
(perampanel)
Oral Suspension

Read this Instructions for Use before you start using FYCOMPA Oral Suspension and each time you get a refill. There may be new information. This leaflet does not take the place of talking to your healthcare provider about your medical condition or treatment.

Prepare the FYCOMPA Oral Suspension dose

You will need the following supplies: **See Figure A**

- FYCOMPA Oral Suspension bottle
- Bottle adapter
- Dosing syringe (2 dosing syringes are included in the FYCOMPA Oral Suspension box)

Figure A

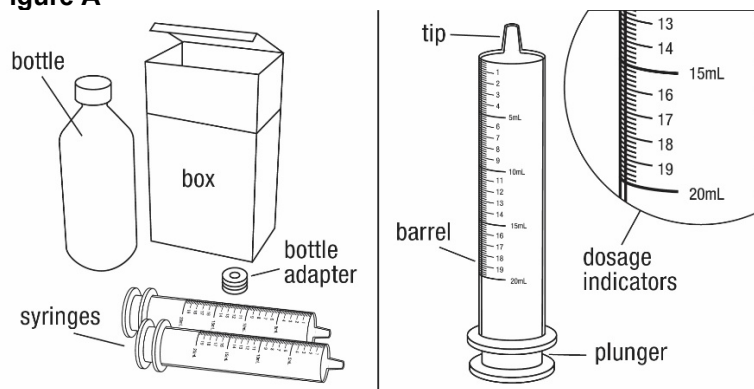

Step 1. Remove the FYCOMPA Oral Suspension bottle, bottle adapter, and 2 syringes from the box. **See Figure A**

Step 2. Shake the bottle well before each use. **See Figure B**

Figure B



Step 3. Uncap the bottle and insert the bottle adapter into the bottle by pressing downward. **See Figure C and Figure D**

Figure C

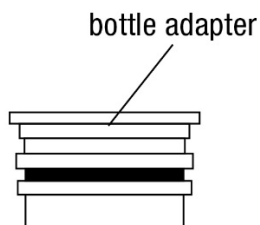
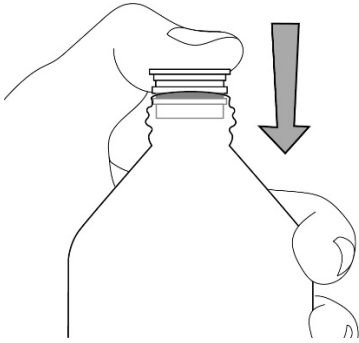

Figure D



After the bottle adapter is in place, it cannot be removed.

Step 4. Check the dose in milliliters (mL) as prescribed by your healthcare provider. Find this number on the syringe. **See Figure E**

Figure E

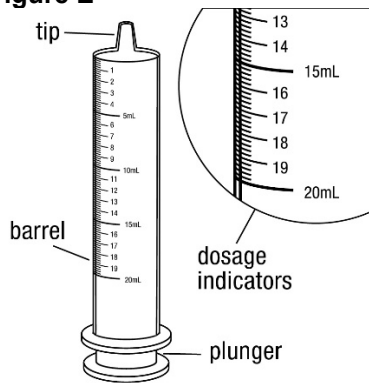

Step 5. Push the plunger of the syringe all the way down then insert the syringe into the upright bottle through the opening in the bottle adapter. **See Figure F**

Figure F

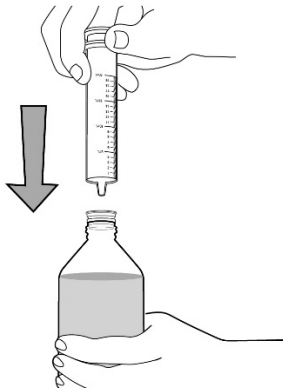

Step 6. With the syringe in place, turn the bottle upside down. Pull the plunger to withdraw the dose prescribed by your healthcare provider (the amount of liquid medicine in Step 4). If you see air bubbles in the oral syringe, fully push in the plunger so that the oral solution flows back into the bottle. Then, withdraw the prescribed dose of oral suspension. **See Figure G**

Figure G

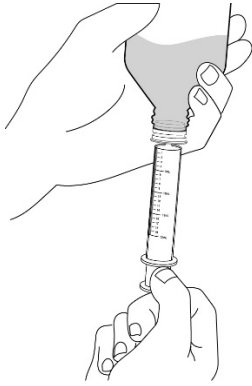

Measure the mLs of medicine from the end of the plunger.

Step 7. If the dose is more than 20 mL, you can use:

- 2 syringes

or

- 1 syringe, taking 2 steps to draw up the medicine in that same syringe

For example:

If the dose is 24 mL, draw up 20 mL in the first syringe and the remaining 4 mL in the second syringe.

or

If the dose is 24 mL, draw up 20 mL in the single syringe and squirt the medicine into the mouth, then draw up the remaining 4 mL in that same syringe.

If the dose is more than 20 mL, repeat Steps 4 through 6 when drawing up the remaining dose of medicine.

Step 8. Turn the bottle right-side up and remove the syringe from the bottle adapter. **See Figure H**

Figure H

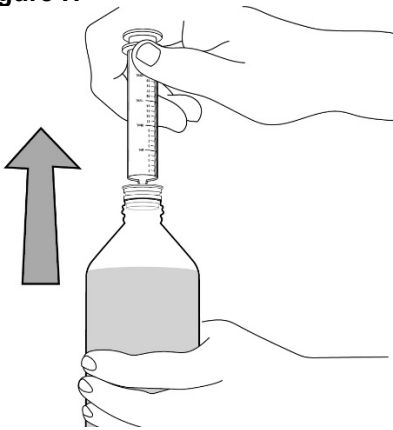

Step 9. Slowly squirt the FYCOMPA oral suspension directly into the corner of the mouth until all of the liquid medicine is given. If you need 2 syringes for the dose, slowly squirt the medicine from the first syringe into the mouth, then slowly squirt the medicine from the second syringe into the mouth. **See Figure I**

Figure I



Step 10. Rinse the syringe (or syringes) with tap water after each use. **See Figure J**

- Fill a cup with water
- Pull back on the plunger and draw the water from the cup into the syringe
- Push down on the plunger to release the water into the sink

Figure J

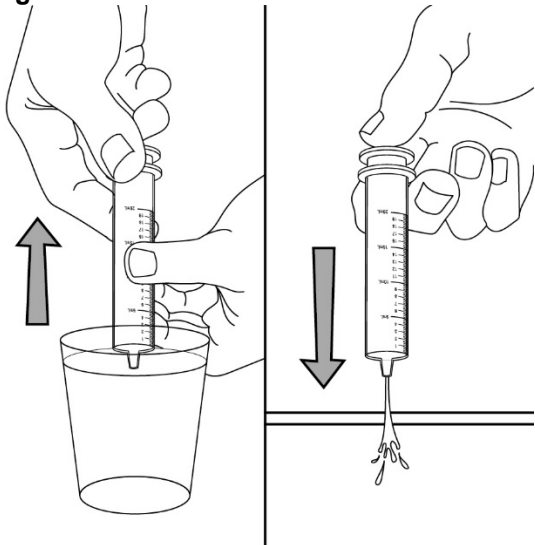

Step 11. Cap the bottle tightly. The cap will fit over the bottle adapter. **See Figure K**

Figure K

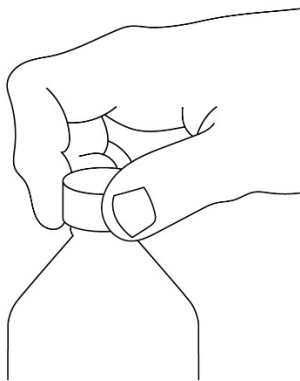

How should I store FYCOMPA Oral Suspension?

- Store FYCOMPA oral suspension below 86°F (30°C). **Do not freeze.**
- Replace the cap tightly after opening.

- Use FYCOMPA oral suspension within 90 days after the bottle is first opened.
- After 90 days safely throw away any FYCOMPA Oral Suspension that has not been used.

This Instructions for Use has been approved by the U.S. Food and Drug Administration.

FYCOMPA® is a registered trademark owned by Catalyst Pharmaceuticals, Inc.

Marketed by Catalyst Pharmaceuticals, Inc., Coral Gables, FL 33134

©2023 Catalyst Pharmaceuticals, Inc.

Revised: 06/2023